

BUYING GUIDE

BUYING GUIDE COOLERS

FIND THE RIGHT COOLING BOX FOR YOUR VEHICLE

 **DOMETIC** **OUTDOOR**

CONTENTS

CRITERIA TO CONSIDER WHEN SELECTING THE “RIGHT” COOLER

05 – 07

Which “mobile” cooling technologies are available?

08 – 09

On the move: where and how?

10

What level of cooling performance do I expect?

11

Which energy source do I want to use?

12

What about energy consumption?

13

Does it bother me if the cooler makes noise?

14

What size should the cooler be?

16 – 17

Ambassador Sebastian Canaves

18 – 37

Product range

38 – 49

Technical data

YOUR COOLER – AS INDIVIDUAL AS YOU ARE!



We offer a vast range of coolers. To be precise, we have the world's largest selection of coolers, developed for small and large mobile homes, for yachts and boats, for cars, trucks and vans.

In order to find out which cooler is most suitable for you, your vehicle and your ideas of comfort, you should ask yourself a few questions prior to the purchase. A bit of technical background knowledge won't go amiss, either. You will be able to gain that from this brochure – step by step it will lead you to a good buying decision. On the last pages you find our entire cooler range so that you can realize your decision straight away.

INFO TAGS FOR HELP

Here are the tags most commonly used for mobile cooling by Dometic. They will allow you to identify all the basic features of a cooling appliance at first glance.



CONTROLLED VIA WIFI APP OR BLUETOOTH



POWERED BY GAS



COOLING AND HEATING



SUITABLE FOR SOLAR OPERATION



FOR MAINS OPERATION
(230 VOLTS OR 100 – 240 VOLTS AC)



ABSOLUTELY SILENT



FOR OPERATION ON 12 OR 24 VOLTS DC

FOUR COOLING SYSTEMS

WITH DIFFERENT ADVANTAGES

Four different cooling systems ensure that everything stays fresh on the move. Why as many as four? The reason is that each of them has its own particular advantages that recommend them for certain conditions. So please find a short explanation of the functional principles of the different technologies below.

1. PASSIVE COOLING

2. ABSORPTION COOLING

3. THERMOELECTRIC TECHNOLOGY

4. COMPRESSOR TECHNOLOGY



FOUR COOLING SYSTEMS

FOR MOBILE APPLICATIONS

1. PASSIVE COOLING

Passive coolers offer a key benefit – they require no power supply. Instead, they feature a highly effective polyurethane foam insulation, combined with a tight closing labyrinth seal. Fitted with cold packs or ice cubes, they keep the contents fresh for several days, depending on the use and weather conditions.

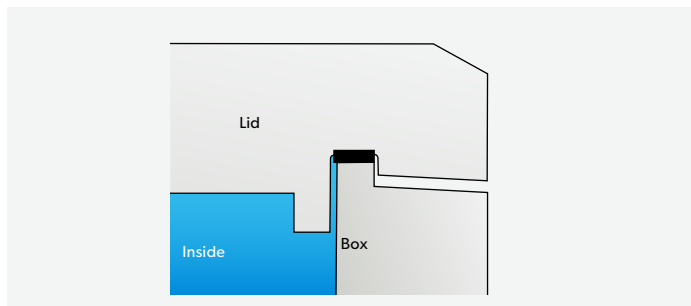

PASSIVE COOLERS

- Require no external energy supply
- Keep things fresh for several days, depending on the ambient temperature
- Highly effective PU insulation, combined with a tight closing labyrinth seal
- Easy to clean
- Optimised volume/weight ratio

2. ABSORPTION COOLING

A concentrated ammonia solution is heated in a boiler and expelled as vapour. The pressurised ammonia gas is then liquefied in a condenser. Supplied with hydrogen, it evaporates and in the process extracts heat from the storage container. The ammonia gas then enters the absorber where it is reabsorbed in a weak solution of ammonia. Finally, the saturated solution flows back to the boiler where the whole cycle starts again.

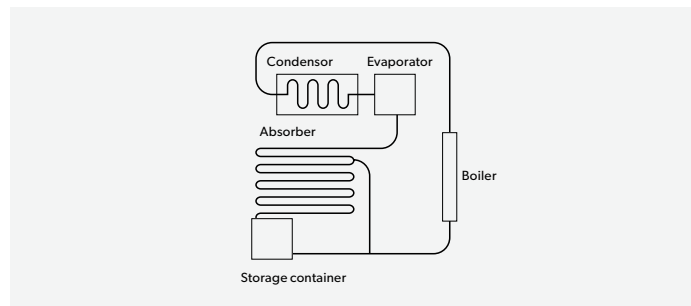

ABSORPTION COOLERS

- Gas-powered cooling independent of electricity
- 12 volts DC and 230 volts AC
- Silent operation
- Cooling performance depending on the ambient temperature



OUR TIP!

The Dometic compressor coolers remain cold even when it's hot. It is ideal for mobile use and for a barbecue at home, where it can be connected to the mains to provide temporary storage for meat and drinks.

3. THERMOELECTRIC TECHNOLOGY

The thermoelectric principle was discovered in 1834 by J.C.A. Peltier, which is why the temperature generating parts of thermoelectric systems are referred to as Peltier elements. Thermoelectrics are based on the fact that cold or heat energy (depending on the polarity) is generated when a DC current is conducted between different types of metal.

The heating or cooling capacity is further enhanced by heat exchangers and air fans. Ideal for low and medium cooling volumes.

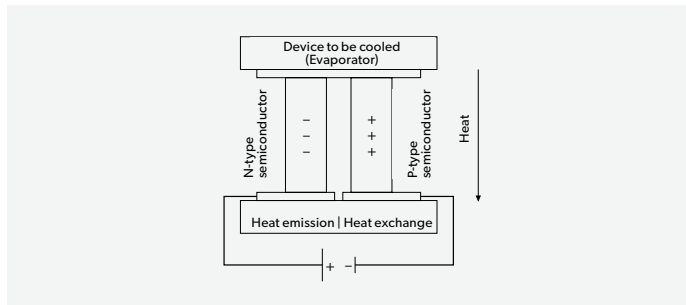

THERMOELECTRIC COOLERS

- 12 / 24 / 230 volts
- Impeccable operation in inclined position
- Lightweight and low-cost
- Cooling performance depending on the ambient temperature

4. COMPRESSOR TECHNOLOGY

Compressor units operate using a refrigerant that changes from liquid to gaseous state in the evaporator. The evaporation extracts heat from the interior of the cooling unit – the temperature drops. The compressor draws in the refrigerant, compresses it and passes it on to the condenser. Here, the absorbed heat is released to the atmosphere. The refrigerant liquefies again and flows to the evaporator, where the cycle begins again.

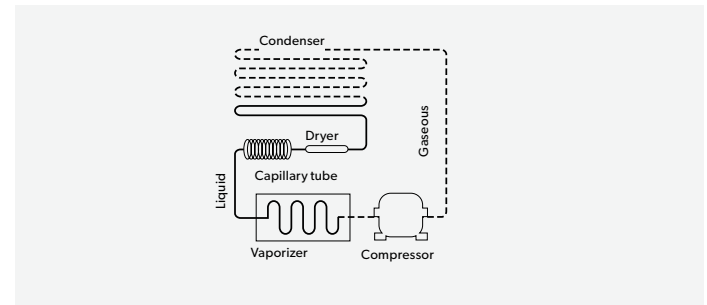

COMPRESSOR COOLERS

- Excellent cooling performance even at extreme ambient temperatures
- 12 / 24 / 100 – 240 volts
- Low power consumption
- Suitable for solar operation
- Integrated battery protection

ON THE MOVE: WHERE AND HOW?

TEMPERATURE CONDITIONS AT YOUR HOLIDAY DESTINATION

It makes quite a difference whether you mostly drive the vehicle you use for work or leisure in a moderate climate or in the hot, sunny south. It's a fact that the cooling performance of thermoelectric, absorption or passive coolers is influenced by the respective ambient temperature. Compressor coolers, by contrast, are independent of the ambient temperature.

When the daytime temperature often rises to about 40 °C and more, as it tends to do in Spain, Greece and Croatia for example, thermoelectric systems cannot be expected to deliver satisfactory cooling results. Depending on where you place your cooler, you may be luckier with an absorption appliance. If you want to be on the safe side, however, you are best advised to choose a compressor cooler for reliable cooling performance in hot regions.

TYPE OF COOLER	OUTSIDE TEMPERATURE	INTERIOR TEMPERATURE ACHIEVED
Absorption technology (CombiCool ACX3 40) Up to 30 °C below ambient temperature	40 °C	10 °C
Thermoelectric (TropiCool TCX 21) Up to 27 °C below ambient temperature	40 °C	13 °C
Thermoelectric / Compressor technology (CoolFun CK 40D Hybrid)		
Thermoelectric: Up to 20 °C below ambient temperature	40 °C	20 °C
Compressor technology	40 °C	Adjustable temperature: +20 °C to -15 °C
Compressor technology (CFX3 45)	40 °C	Adjustable temperature: +20 °C to -22 °C

Pick a cooler to match the ambient temperature. It is an important aspect to consider when you decide whether it has to be a passive cooler, a versatile absorption cooler, a lightweight thermoelectric unit or a compressor box with cooling power independent of the ambient temperature.



Thermoelectric / Compressor technology

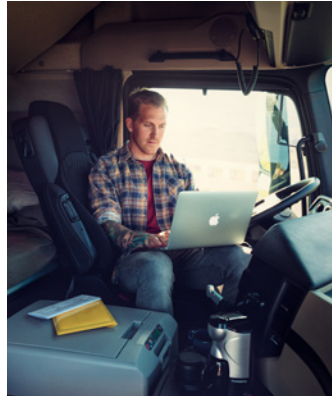

Thermoelectric technology



Absorption technology

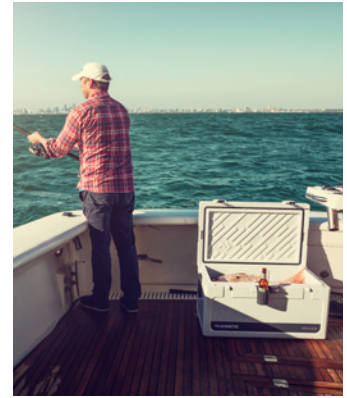

Passive cooling

TWO COOLING SYSTEMS IN ONE BOX

Ingenious technology for even more versatile use: the Dometic CoolFun CK 40D Hybrid incorporates a high-performance compressor as well as a thermoelectric unit. In compressor mode (230 volts) it provides powerful cooling down to -15°C , regardless of the temperature outside. The integrated thermoelectric system fills in when the cooler is used in the vehicle. Connected to the 12-volt battery it cools food and drinks up to 20°C below the ambient temperature while driving. It is the ideal awning fridge – and just as great for your home or garden party.



WHAT LEVEL OF COOLING PERFORMANCE DO YOU NEED?

SMALL-SCALE FRESHNESS OR FULL POWER?

You like to go on day trips and keep fruit, snacks and soft drinks nice and cool? Or are you on the road for weeks on end with your mobile home or truck and therefore wish to take more temperature-sensitive food such as meat, sausages and fish as well?

While an inexpensive thermoelectric cooler will do in the first case, the second situation definitely calls for an absorption or compressor appliance. If you want to be on the safe side when travelling in hot regions, we recommend you to opt for a compressor cooler.



OUR TIP!

Dometic Cool-Ice passive coolers are an excellent choice for fishing trips. They keep bait and catch fresh for many hours without an external energy supply. A set of cold packs or ice cubes will do.







COOLING SYSTEM	
Passive cooling	Insulating effect depending on the ambient temperature
Absorption technology	Refrigeration depending on the ambient temperature, ice cubes on the evaporator
Thermoelectric technology	+5 °C depending on the ambient temperature
Compressor technology	Adjustable temperature setting +20 °C to -22 °C (CFX3)

WHICH ENERGY SOURCE DO YOU WANT TO USE?

12 VOLTS, 24 VOLTS, 230 VOLTS, GAS, SOLAR ENERGY?

Is it okay for you to run your cooler “only” from the 12 or 24-volt vehicle battery? Would you like a 230-volt mains option as well? Or are you one of those camping enthusiasts who prefer cooling with gas? The Dometic cooler range accounts for all these energy options. Compressor units can even be run with solar power – a plus factor you should exploit when travelling in the sunny south a lot.

If gas operation is all-important to you, absorption cooling is your system of choice. Dometic compressor coolers excel for their energy-efficient operation. Integrated battery protection puts you on the safe side when the unit is powered via the vehicle battery. This feature is fitted as standard on all Dometic compressor boxes as well as the thermoelectric coolers of the TCX series.

ENERGY SOURCE		
Absorption technology	12 volts / 230 volts / gas	  
Thermoelectric technology	12 volts / 24 volts / 230 volts	 
Compressor technology	12 volts / 24 volts / 100 – 240 volts	 

ENERGY SOURCE WHEREVER YOU GO

Integrated cradle for a gas cartridge for the CombiCool ACX3 40G absorption cooler.



WHAT ABOUT ENERGY CONSUMPTION?

DEALING WITH LIMITED ENERGY RESOURCES

In mobile applications electrical devices are mostly supplied from “limited energy sources”. That means energy consumption is a crucial factor to consider. The table below tells you how to calculate the consumption of specific cooling appliances. It becomes obvious

that longer periods of use (e.g. more than 2 days) call for the energy-efficient compressor technology. The owners of an absorption unit have an alternative, though: gas operation.



COOLING TECHNOLOGY	FORMULA	EXAMPLE	AMPERAGE
Absorption technology CombiCool ACX3 40	Power input: voltage	85 watts: 12 volts	= 7 Ah / h, 168 Ah / day
Thermoelectric technology CoolFun SCT 26	Power input: voltage	47 watts: 12 volts	= 3.92 Ah / h, 94 Ah / day
Compressor technology CFX3 45	Current draw x average running time* (52 W: 12 V = approx. 4.3 A)	4.3 A x 20%	< 1 Ah / h, < 24 Ah / day

*22 % average running time at 32 °C ambient temperature and 5 °C inside the unit

HOW MUCH “NOISE” IS ACCEPTABLE?

DIFFERENT NOISE EMISSION LEVELS

The noise emission of a cooler is not much of an issue while travelling in a car or truck. It’s a different story when it is kept in the room you are staying or even sleeping in. If you – like most camping enthusiasts – wish to place your cooler under the awning, you are best advised

to choose an absorption unit. This type of cooler is almost silent. If the occasional start of the compressor does not really bother you though, you will be just as happy with a compressor box.



COOLING TECHNOLOGY	NOISE EMISSION
Absorption technology	Absolutely silent 
Thermoelectric technology	Continuous fan noise
Compressor technology	Occasional, quiet running noise of the compressor and fan

WHAT SIZE SHOULD YOUR COOLER BE?

SOLUTIONS FROM XS TO XXL

Of course we can deliver coolers in any size and volume you want. Please consider, however, that the larger the cooling compartment, the more energy is required. Moreover, a jumbo-size cooler is heavier and more difficult to store than a compact model. On the other hand, a compact cooler would hardly be sufficient for a family of five – they would certainly need more cooling capacity. The same is true for truck drivers, who tend to be on the road in pairs and for days on end. And, of course, skippers planning a long trip will require a different cooler than anglers who just want to safely store the catch of the day.

Conclusion: The cooler you choose should be a perfect match for you, your companions and your travelling habits, but also in terms of size and the space available in your vehicle.



OUR TIP: "TAKE TWO!"

For day tours and spontaneous picnics we recommend the thermoelectric TropiCool TCX 21 for example. In the morning you put soft drinks and sandwiches in it – in the evening it's empty. It's also great for everyone having to travel for work a lot. Long trips, however, require a somewhat larger and stronger solution.

Take the CFX3 55 compressor cooler for instance. It neatly fits into the storage compartment and is great for the occasional boat trip as well. Its greatest bonus is its incredible performance. The sun may be scorching hot, yet this unit plays it cool!

COOLING SYSTEM	CAPACITIES AVAILABLE IN THE DOMETIC RANGE
Passive cooling	13 – 110 litres
Absorption technology	31 – 40 litres
Thermoelectric technology	7 – 37 litres
Compressor technology	11 – 99 litres



CREATE SEPARATE TEMPERATURE ZONES SIMULTANEOUSLY IN ONE BOX?

DZ stands for dual-zone, an innovative technology that allows you to store different temperature goods simultaneously in one cooling box. The two temperature zones have separate controls, so you can set them as required.

If it's just ice cubes you want, the CFX3 55IM (p. 32) gives you a smart solution. This compressor box is the first one in the world of single-zone portable refrigeration able to produce ice even when set to refrigeration. Make ice cubes in a 3 hours and have ample capacity for your fresh provisions!

SEBASTIAN IS TRULY ON A MISSION TO EXPLORE THE WORLD



Sebastian Canaves is always on-the-go and off-the-path, traveling the world and sharing his experiences thanks to his Dometic CFX3 powered cooler.

With over 100 countries under his belt, Sebastian Canaves is truly on a mission to explore the world. The overlander spends his days adventuring in his Jeep and running Germany's largest online outdoor travel and adventure website, off-the-path.com.

Growing up on the island of Mallorca, Sebastian spent his first fourteen years hiking, swimming, and sailing. Falling in love with nature and the thrill of the outdoors was built in to his childhood. His family uprooted and moved to Germany when he was a teenager. After he graduated from high school, he left for Brisbane, Australia to start his career. Since then, he has lived in ten countries and speaks five languages fluently, and is always on the move. His first taste of mobile living was in Western Australia where he spent six weeks in a tiny campervan with the bare minimum of supplies and utilities. These humble beginnings were a stark contrast to today, as Sebastian has fitted his Jeep Wrangler into the perfect traveling camper mobile with all the things he needs to stay dry, warm, and happy no matter where he roams.

When building out his Jeep Wrangler, Sebastian made sure to design it to fit his Dometic CFX3 35 Powered Cooler. The state of the art cooler keeps a constant temperature even in the harshest climates and has a rugged exterior built to keep up with the journey and take a beating along the way. With the CFX3, Sebastian and his travel companions can ensure that they will be well fed on remote adventures and healthy meals can last as long as would in a full sized home cooler. Healthy meals, even on the road, without ever needing to stop for ice or to worry about food spoiling or floating in water is a true game changer for Sebastian.

The CFX3 can last a whole weekend off the grid when paired with the Dometic PLB40 Portable Lithium Battery. This compact but powerful battery can recharge along the way via the vehicle, power the CFX3 constantly, along with any of the modern electronics Sebastian and his crew may need and kitchen appliances that would otherwise feel like an impossible luxury.

Recently, Sebastian took Dometic to one of his favorite places on the banks of the Isar River for a cookout. The tranquil camping spot is ideal for a relaxing evening of good food without any compromises. "We love the proximity to the river and the nature and love sitting by a fire to enjoy a good meal," Sebastian said. "The CFX3 and PLB40 were perfect as we were able to move our kitchen right to

the river and the fire. We barbecued salmon on wood planks with some potatoes in herbs. It was very delicious!" Not having to worry about spoiling food, melting ice, limited space, or running out of energy gives Sebastian and his crew the power to be present in every moment. To those considering car camping for themselves, Sebastian says: "Do it! You'll get to know yourself and the world better and end up seeing beautiful places you didn't have on your mind!" The overlanding lifestyle is a constant education. Sebastian has learned that things rarely go as planned on a trip and that part of the adventure is being prepared for everything with the right gear and the right attitude. Along his many travels, Sebastian has swam with sharks in Australia, bungee jumped backwards in Scotland, and canoed in Sweden, along with many other feats. Despite his extensive travel, his bucket list is impossibly long. Most recently, he took to the South African bush on horseback. Some day, he hopes to make it to Alaska. Right now, Sebastian doesn't see an end to his overlanding adventures, he plans to keep going, to inspire others, and to expect the unexpected every day.



[instagram.com/offthepath](https://www.instagram.com/offthepath)



More information under:
DOMETIC.COM > [OUR BRAND](#) > [DOMETIC AMBASSADORS](#)



DOMETIC DRINKWARE

STAINLESS STEEL CUPS, BOTTLES AND TUMBLERS

Designed to keep drinks cold or warm for longer, Dometic thermo bottles can be used for water, coffee or tea. Their tough stainless steel construction makes the insulated vacuum sealed bottles fit for years of use and reduces the use of disposable bottles.

The Dometic drinkware range also includes matching cups and tumblers – all made from high-quality stainless steel, BPA-free and dishwasher-safe. Practical on the road: Dometic bottles, cups and tumblers fit all standard cup holders.

KEY BENEFITS

- Fits all standard cup holders
- Double wall insulation keeps hot drinks hot for 6 h and cold drinks cold for 12 h
- Durable construction with comfortable, ergonomic design
- BPA-free
- Dishwasher-safe



NEW CUP50

Stainless steel cups,
500 ml

NEW TMBR32 / TMBR60

Vacuum-insulated thermo tumblers,
320 / 600 ml

NEW THRM48 / THRM66

Vacuum-insulated thermo bottles,
480 / 660 ml



DURABLE

Stainless steel body and lid is impact
and scratch resistant



HOT OR COLD

Double wall insulation keeps drinks hot
for 6 h or cold for 12 h



DISHWASHER SAFE

Cleaned easily in the dishwasher and
ready for your next adventure



NEW DOMETIC PATROL

COOL FOR ACTION

Our high-performance Patrol ice and passive coolboxes keep ice frozen for days. Built to last trip after trip with thick PU insulated walls, a single piece rotomoulded construction, and a full-length hinge pin. More than just a box to put ice in, these cool boxes offer

smart features like Patrol's leak proof drain, deep-freeze lid seal and one-hand rubber latch opening. For extra-functionality, a clever accessory dock can house optional accessories including: a bottle opener, cup holder or fishing rod holder.



LARGE DRAIN

Leak-proof drain for easy cleaning



HIGHLY INSULATED

Keeps ice cold for days



EASY ACCESS

Open with one hand thanks to convenient rubber latches

KEY BENEFITS

- Thick PU insulation keeps ice frozen for days
- Large, leak-proof drain makes cleaning easy
- Deep-freeze lid seal ensures no gaps for air to enter or escape
- Rugged construction with one-piece rotomolded PE
- One-handed rubber latches for convenient opening and closing of the lid



NEW PATROL 55
Portable passive cooler, 54 l

NEW PATROL 35
Portable passive cooler, 36 l

NEW PATROL 20
Portable passive cooler, 19 l



TOUGH DESIGN

One-piece rotomolded polyethylene



CONVENIENT DOCK (OPTIONAL)

Multi-use dock for optional accessories such as cup holder, bottle opener or fishing rod holder



CUSTOMISABLE

Each box comes with a set of stickers for personalisation.

DOMETIC COOL-ICE

PASSIVE COOLERS IN HEAVY DUTY QUALITY

Dometic passive coolers feature an extremely effective insulation system. Fitted with ice packs or ice cubes, they can keep groceries, fish, bait and wild game fresh for several days. The new facelift models of the popular series are even cooler. Practical accessories like seat cushions, rod holders and bottle openers make them indispensable companions for fishermen, hunters and other nature lovers. The modular storage system, consisting of wire baskets and dividers, organises the content. Available for all new Cool-Ice models (43 to 111 litres).



ACCESSORIES

Cool-Ice CI boxes are even cooler with the right accessories. Seat cushions, fishing rod holders and bottle openers make them indispensable companions for anglers, hunters and other nature lovers.

See p. 40



WCI 22 AND CI 42
ALSO IN GREEN

DOMETIC BORDBAR

COMPACT UNITS FOR THE CAR

What was formerly reserved for luxury automobiles is now affordable for everyone. TB 08 and TB 15 provide drivers and passengers with cool snacks and drinks, and they can even keep hamburgers and chips warm. Placed on the front passenger seat or the centre of the rear seat, they are fastened with the safety belt.



12/24 V



230 V



COOLING
AND HEATING
MODE

- Cooling up to 20 °C below ambient temperature
- Heating up to +65 °C
- Easy to fasten with the seat belt on front passenger seat or centre of rear seat



BORDBAR TB 08

Thermoelectric car cooler, 8 l

BORDBAR TB 15

Thermoelectric car cooler, 15 l

BORDBAR TF 14

Thermoelectric car cooler, 14 l



BORDBAR AS 25

Thermoelectric car cooler, 20 l

DOMETIC COOLFUN SCT 26

COOLING WHEREVER YOU NEED IT!

The Dometic CoolFun SCT 26 offers cooling convenience whether you're at work or at the beach! Cooling up to 18 °C below ambient temperature. The USB port in the lid is handy for charging mobile devices and the versatile carry handle also act as a support or lock for the lid. Using high-performing thermoelectric cooling technology, this unit is very competitively priced. Enjoy ice cool refreshment and keep food fresh, wherever you are!

- Versatile carrying handle serves to support or lock the lid
- USB port for charging mobile devices
- 25 l capacity has room for 1.5 l bottles
- Cooling up to 18 °C below ambient temperature
- 12/24 V DC



12/24 V



COOLFUN SCT 26

Portable thermoelectric cooler, 25 l

DOMETIC TROPICOOOL TCX

COOLBOXES WITH ACTIVE BATTERY PROTECTION - ALSO WARMS FOOD

Fresh design with soft -touch controls and a digital display – these are the hallmarks of the new Dometic TropiCool TCX series. The new generation of our popular high-tech coolers features a lot of inner values: intelligent power-save circuit, individually adjustable temperature, and an active battery protection system that prevents excessive discharging of the vehicle battery. TopiCool TCX coolers provide cooling up to 27 °C (TCX07 25 °C) below the ambient temperature. If desired, they will also keep food warm. Activating the heating function supplies temperatures of up to +65 °C.

- Cooling up to 27 °C (TCX07 25 °C) below ambient temperature, heating up to +65 °C
- 12 / 24 / 230-volt connection as standard with priority circuit for mains operation
- Intelligent power-save circuit
- Active battery protection prevents deep discharge of the vehicle battery
- TC special electronics with a soft -touch control panel



12/24 V



230 V



COOLING
AND HEATING
MODE



ACTIVE BATTERY
SECURITY



TROPICOOOL TCX 07

Portable thermoelectric cooler, 7 l



TROPICOOOL TCX 14

Portable thermoelectric cooler, 15 l



TROPICOOOL TCX 21

Portable thermoelectric cooler, 21 l



TROPICOOOL TCX 35

Portable thermoelectric cooler, 33 l

DOMETIC CF 11

COOLING COMFORT THE EASY WAY

The lightweight compressor technology and super-slim design of the Dometic CF 11 make mobile cooling of food and beverages easy. Delivering a top cooling performance, the CF 11 excels with

minimal power consumption, regardless of the ambient temperature. Wherever you are going, take the cool with you!



12/24 V



100 – 240 V



SUITABLE
FOR SOLAR

KEY BENEFITS

- Extremely compact, super-slim design
- Adjustable temperature setting from +20 °C to -18 °C
- With shoulder strap for easy transport
- Compact compressor, therefore light in weight
- 12 or 24 V DC, 100-240 V AC
- Total Volume 11 l



**Our best sellers
for car drivers!**
Featuring interior
lighting and a user-
friendly display



COOLFREEZE CF 11

Portable compressor cooler, 11 l



DRINK HOLDERS

Two integrated drink holders



QUICK CHECK

Digital temperature display

NEW DOMETIC CDF2 36

COOLING COMFORT THE EASY WAY

The lightweight compressor technology and slim design of the Dometic CDF2 36 makes cooling of food and beverages easy. The CDF2 36 has been improved in several ways: On the one hand the recessed grip provide more carrying convenience and on the other hand the integrated guide elements for straps or safety belts ensure a safer and easier to handle fixation in a vehicle. The improved lid

with its robust hinge and the more user-friendly latch design now has an even surface and can be used as a table. Performance is another plus factor: reliable cooling from +10 °C to -15 °C, regardless of the outside temperature and with minimal power consumption.



12/24 V



SUITABLE
FOR SOLAR



KEY BENEFITS

- Total volume of 31 l fits 49 cans or five 1.5 l bottles
- Compact design
- Refrigeration from +10 °C to -15 °C
- Digital display and LED interior light
- Integrated handles for more ergonomic carrying
- Integrated guide elements for easy fixation in a vehicle with straps or safety belts
- Refrigeration from +10 °C to -15 °C



EASY OPENING LATCH

Quick access to the interior



KEEP IT ORGANIZED

12 or 24 V DC connections in a practical arrangement

NEW COOLFREEZE CDF2 36

Portable compressor cooler, 31 l

DOMETIC CFF

A VERSATILE COMPANION FOR LIFE'S GREAT ADVENTURES

Things are changing when you are out for an adventure – be prepared with a robust and versatile companion from Dometic's CFF family. Rely on impressive cooling capabilities and face

changing demands with an efficient interior storage and a flexible lid that can be opened either side, while storing food and beverages for short stays or long trip dinners.



12/24 V



100 – 240 V



SUITABLE
FOR SOLAR



CFF 35

Portable compressor cooler, 34 l



CFF 45

Portable compressor cooler, 44 l



SPACIOUS AND FLEXIBLE STORAGE

Full-sized basket and removable divider



DOUBLE-SIDED OPENING LID

Easy access from either side

KEY BENEFITS OF THE NEW CFF MODELS

- Double-sided opening lid for CFF 35 and CFF 45
- User-friendly lid hinge design
- Fits standard 1.5 l bottles upright
- Energy efficient design provides fast and excellent cooling, even in extremely high outside temperatures
- Can be set between +20 °C and -18 °C
- Robust construction
- Convenient carry handles
- Dimmable digital temperature display



12/24 V



100 – 240 V



SUITABLE
FOR SOLAR



NEW



NEW CFF 20

Portable compressor cooler, 21 l



NEW CFF 70DZ

Portable compressor cooler, 70 l



DIMMABLE LED SCREEN

Displays cooling temperature in any ambient light



STRONG HANDLES

Glass filled nylon and steel handle for reliable use



LED LIGHT

Energy efficient LED interior light



DOMETIC CFX3

YEARS OF INNOVATION FOR COOLING PERFECTION

Take control of outdoor adventures like never before with the Dometic CFX3. Enjoy reliably healthy food and cold drinks thanks to Dometic's market leading VMSO3 variable-speed compressor cooling technology. Its optimized software ensures superior cooling and energy efficiency. The CFX3 features durable and

lightweight fender frames to protect the cooler, making it ideal for use in harsh outdoor environments. Strong, spring-loaded aluminum handles make it easy to lift and carry. Adjust the cooling temperature of your CFX3 on the TFT display screen or download the Dometic app and roam free without worry.



USER-FRIENDLY INTERFACE

The stylish TFT LCD user interface displays operating status



RUGGED CONSTRUCTION

Fender frames protect the unit from damage



OPTIMIZED VMSO3 CONTROLLED COMPRESSOR

Efficient variable-speed cooling

KEY BENEFITS

- Heavy-duty yet lightweight construction, fender frame protected edges and stainless steel hinges
- CFX3 smartphone app allows temperature control via WiFi or Bluetooth and provides performance history
- Powerful VM303 compressor cooling technology
- 3-stage dynamic battery protection system prevents a dead car battery or allows a deep draw on dual batteries
- Generous storage capacity of 25 – 99 l
- Built-in TFT user interface displays operating status
- Excellent insulation
- IP44 rated, colour display IP64 rated



12/24 V



100 – 240 V



SUITABLE
FOR SOLAR



CONTROLLED
VIA WIFI OR
BLUETOOTH



NEW CFX3 25

Portable compressor cooler, 25 l



CFX3 45

Portable compressor cooler, 46 l



CFX3 100

Portable compressor cooler, 99 l



FLEXIBLE POWER OPTIONS

Powered by 100 – 240 V AC, 12/24 V DC or battery power, solar compatible



DISCOVER OUR RANGE OF ACCESSORIES

We also offer a range of accessories to get the most out of your cooler, including a durable insulated protective cover and fridge slide.

See p. 46-47

DOMETIC CFX3 55IM

PRODUCES ICE IN A MATTER OF HOURS

In a first for single-zone portable cooler, the CFX3 55IM produces ice even when the unit is set to a higher temperature, thanks to the built-in ice maker. It comes with two removable ice trays for cold drinks no matter where you are or how long you've been away.

The trays feature snap-on silicon lids, so water won't spill inside the cabinet of your CFX3. Just fill the trays, place them in the dedicated ice maker, which can produce ice even if you've set the cabinet of the CFX3 at a higher temperature, and enjoy ice in a matter of hours.



NEW CFX3 APP

Temperature control via CFX3 App



REMOVABLE ICE TRAYS

Produce ice in a matter of hours



12/24 V



100 - 240 V



SUITABLE
FOR SOLAR



CONTROLLED
VIA WIFI OR
BLUETOOTH



CFX3 55IM

Portable compressor cooler, 53 l

DOMETIC CFX3 DZ

SEPARATE TEMPERATURE ZONES

Dometic CFX3 DZ series coolers satisfy all your needs with their dual-zone system. The two temperature zones have separate controls, so they can be precisely set as required. Each compartment can be individually controlled from +20 °C to -22 °C. On top of this,

the high-tech coolers give you a nice extra feature: Using the CFX smartphone app, you can conveniently control the temperature via WiFi or Bluetooth.



12/24 V



100 – 240 V



SUITABLE
FOR SOLAR



CONTROLLED
VIA WIFI OR
BLUETOOTH



CFX3 75DZ

Mobile compressor dual-zone cooler, 75 l



CFX3 95DZ

Mobile compressor dual-zone cooler, 94 l



NEW DOMETIC COMBICOOL ACX3

12 VOLTS, 230 VOLTS OR GAS COOLING WHEREVER YOU WANT!

You've found a dream place to stay but there's no way to get there with the vehicle and no mains hook-up either ... Don't worry, CombiCool ACX3 absorption coolers from Dometic give you maximum freedom in choosing your picnic site. They run on 12 volts in the vehicle and on 230 volts at home or at a campsite.

In the great outdoors you simply switch over to gas mode. The ACX3 40G is even more versatile and works on a standard gas cartridge. All three ACX3 models provide cooling up to 30 °C below the ambient temperature. Another common feature of the ACX3 family is the elegant aluminium housing with the distinctive lid.



ICE CUBE BOX INCLUDED

Create your own ice cubes with the included ice cube box



INNER VOLUME

Provides space for 1.5 l bottles



OPERATED WITH GAS

Connect your cooler to 12 V DC, 230 V AC or gas

KEY BENEFITS

- Powered by gas, 12 V DC and 230 V AC – guaranteed energy supply, maximizes freedom!
- Absolutely silent operation means no disturbance
- Sturdy housing and attractive design
- Ice cube tray included
- Cooling up to 30 °C below ambient temperature
- Elegant aluminum housing
- Three-stage flame regulation in gas mode



NEW COMBICOOL ACX3 40G
Portable absorption cooler, 41 l



12 V



230 V



GAS



SILENT

NEW COMBICOOL ACX3 30
Portable absorption cooler, 33 l

NEW COMBICOOL ACX3 40
Portable absorption cooler, 41 l

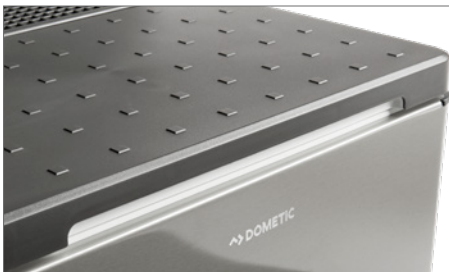

ELEGANT DESIGN

High quality surface with an eye-catching design



STURDY HOUSING

Robust construction with useful details



ENERGY WHEREVER YOU GO

ACX3 40G can be operated with gas cartridges

DOMETIC COOLFUN CK 40D HYBRID

TWO COOLING SYSTEMS IN ONE BOX

Are you looking for a highly efficient cooling appliance for the awning, the patio or the garage workshop? And ideally also for the car or camper vehicle? Then the Dometic CoolFun CK 40D HYBRID cooler is just what you need. It integrates two cooling technologies: powerful compressor cooling on a mains socket, thermoelectric

cooling for operation on the 12 V DC battery of your car or motorhome. The latter is strong enough to keep pre-cooled goods in prime condition throughout the journey to your holiday destination. More benefits: ample 40 l capacity, elegant silver / black finish, integrated handles for perfect portability.



230 V



12 V



COOLFUN CK 40D HYBRID

Portable hybrid cooler, 40 l



ACCESSORIES

Cool box stand for
CoolFreeze boxes

Ref. No.
960000689



ELECTRONIC ACCESSORIES FOR PORTABLE COOLERS

MAINS CONNECTION FOR DC COOLERS

Do you have a portable cooler with a 12-volt or 12/24-volt connection, or are you planning to buy one? Then you will always have the option to run it from the mains too. With the matching Dometic CoolPower mains adapter you can use it on a mains socket at home, in the hotel, or in your holiday home. That will give you a much wider range of possibilities.



COOLPOWER EPS 817

Mains adapter for hassle-free connection of thermoelectric 12-volt cooling appliances to the 230-volt mains.

Portable
power for
12 V devices



reddot design award
winner 2019

PLB40

Portable lithium battery, 40 Ah

DOMETIC PLB40 MAINTAIN POWER AFTER IT'S GONE



The Dometic PLB40 Ah Lithium Iron Phosphate battery delivers high levels of mobile power – up to 40 hours of Dometic CFX3 45 cooling on a single charge (When fridge temperature is 5 °C). Designed to supply power to powered coolboxes and other 12 V appliances while being off-grid. Thanks to its lightweight and compact design you can enjoy true independence and travel off-grid for longer.

- Enables you to travel off-grid for longer
- Three-way charging via 12 V socket, solar panel or AC house power
- Extremely lightweight, ergonomically designed stainless steel carry-handle
- Specifically designed for Dometic CFX3 and other powered coolers
- IP rating IP44







TECHNICAL DATA			
DRINKWARE	CUP50	TMBR32 / TMBR60	THRM48 / THRM66
Ref. No.	Moss 9600029336 Ore 9600029337 Mango 9600029338	320 ml, Moss 9600029330 320 ml, Ore 9600029331 320 ml, Mango 9600029332 600 ml, Moss 9600029333 600 ml, Ore 9600029334 600 ml, Mango 9600029335	480 ml, Moss 9600029324 480 ml, Ore 9600029325 480 ml, Mango 9600029326 660 ml, Moss 9600029327 660 ml, Ore 9600029328 660 ml, Mango 9600029329
Total Volume	500 ml	320 / 600 ml	480 / 660 ml
Insulation	-	Vacuum-insulated	Vacuum-insulated
Material	Stainless steel	Double wall stainless steel	Double wall stainless steel
Dimensions (H x Ø)	128 x 88.5 mm	133 x 84 mm 185 x 92 mm	199 x 73 mm 259 x 73 mm
Weight	80 g	220 / 320 g	280 / 380 g

TECHNICAL DATA			
ICEBOXES	PATROL 20	PATROL 35	PATROL 55
Ref. No.	9600028784 Mist 9600028787 Slate 9600028790 Ocean 9600028792 Olive 9600028794 Mango	9600028785 Mist 9600028788 Slate 9600028791 Ocean 9600028793 Olive 9600028795 Mango	9600028786 Mist 9600028789 Slate 9600029271 Ocean
Total volume (l, approx.)	19	36	54
Dimensions (W x H x D, mm)	526 x 379 x 356	691 x 389 x 414	757 x 417 x 478
Weight (kg, approx.)	8	11.7	15
Material	UV-resistant plastic		
/ Optional extras			
Drink Holder	9108400902		
Bottle Opener	9108400904		
Bracket	9108400901		

4.36 / Dometic Cool-Ice WCI

TECHNICAL DATA			
ICEBOXES	WCI 13	WCI 22	WCI 33
Ref. No.	9600000500	9600000501/ 9600019218	9600000502
Total volume (l, approx.)	13	22	33
Dimensions (W x H x D, mm)	388 x 305 x 245	388 x 313 x 365	400 x 440 x 360
Weight (kg, approx.)	2.8	4.2	5.7
Material	UV-resistant plastic		

4.36 / Dometic Cool-Ice CI

ICEBOXES						
ICEBOXES	CI 42	CI 55	CI 70	CI 85	CI 85W	CI 110
Ref. No.	9600000541 9600019219	9600000542	9600000543	9600000544	9600000545	9600000546
Total volume (l, approx.)	43	56	71	87	86	111
Dimensions (W x H x D, mm)	640 x 355 x 418	570 x 432 x 515	690 x 432 x 515	840 x 432 x 525	840 x 432 x 525	1055 x 442 x 535
Weight (kg, approx.)	8.7	10.6	11.8	14	14.6	18.1
Material	UV-resistant plastic					

/ Optional extras

Seat Cushion	9108400892	9108400893	9108400894	9108400895	9108400895	9108400896
Divider	9108400897	9108400898	9108400898	9108400898	9108400898	9108400898
Basket Small	9108400899	9108400900	9108400900	9108400900	9108400900	9108400900
Beverage Holder & Bracket	9108400901	9108400901	9108400901	9108400901	9108400901	9108400901
Beverage Holder	9108400902	9108400902	9108400902	9108400902	9108400902	9108400902
Rod Holder	9108400903	9108400903	9108400903	9108400903	9108400903	9108400903
Bottle Opener	9108400904	9108400904	9108400904	9108400904	9108400904	9108400904
Fixing Kit	9108400905	9108400905	9108400905	9108400905	9108400905	9108400905



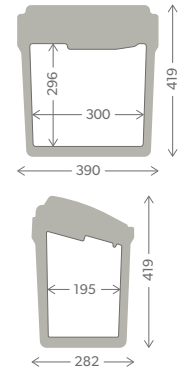
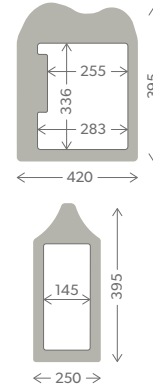
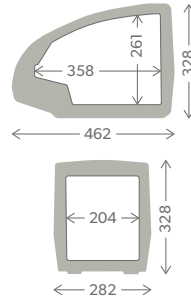
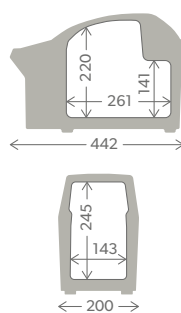

TECHNICAL DATA				
THERMOELECTRIC COOLERS	TB 08	TB 15	TF 14	AS 25
Ref. No.	9600000488	9600000489	9600000499	9600000459
Total volume (l, approx.)	8	15	14	20
Connections	12 V DC	12 V DC	12 V DC	12 V DC / 230 V AC
Consumption at 12 volts DC (watts) at 230 volts AC (watts)	32 -	40 -	36 -	36 40
Energy Class (A – G)	-	-	-	F
Temperature range (°C, approx.) Cooling below ambient temperature Heating	max. 20 +65	max. 20 +65	max. 25 -	max. 18 -
Weight (kg, approx.)	3.2	5.2	4.6	4.3
Test marks	TÜV/GS, E-certified (Automotive EMC Directive)			



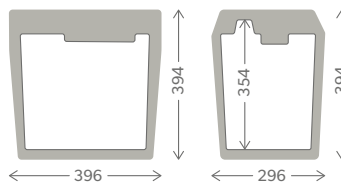

**SCT 26**

TECHNICAL DATA	
THERMOELECTRIC COOLERS	
Ref. No.	9600000485
Total Volume (l, approx.)	25
Connections	12 / 24 V DC
Consumption at 12 volts DC (watts) at 24 volts DC (watts)	47 55
Energy Class (A – G)	–
Temperature range Cooling below ambient temperature (°C, approx.)	max. 18
Weight (kg, approx.)	3.7
Test marks	TÜV/GS, E-certified (Automotive EMC Directive)



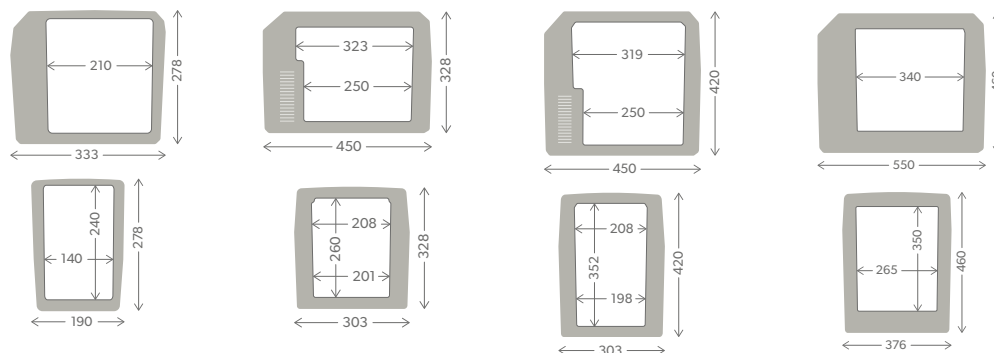

TECHNICAL DATA				
THERMOELECTRIC COOLERS	TCX 07	TCX 14	TCX 21	TCX 35
Ref. No.	9600025390	9600013319	9600013320	9600013321
Total Volume (l, approx.)	7	15	21	33
Connections	12 V DC / 230 V AC	12 / 24 V DC / 230 V AC		
Consumption at 12 volts DC (watts) at 24 volts DC (watts) at 230 volts AC (watts)	47 - 55	46 50 64	46 50 64	46 50 64
Energy Class (A – G)	-	E	E	F
Temperature range Cooling below ambient temperature (°C, approx.) Heating	max. 25 +65	max. 27 +50 to +65	max. 27 +50 to +65	max. 27 +50 to +65
Weight (kg, approx.)	2.8	5.0	6.0	10.0
Test marks	TÜV/GS, E-certified (Automotive EMC Directive)			



TECHNICAL DATA	 CF 11	 NEW CDF2 36
Ref. No.	9600005337	9600028780
Ref. No. UK	9600005338	9600028780
Total Volume (l, approx.)	11	31
Connections	12 / 24 V DC / 100–240 V AC	12 / 24 V DC
Temperature range (°C)	+20 to –18	+10 to –15
Power input (watts, approx.)	35	40
Refrigerant Refrigerant quantity CO ₂ equivalent Global warming potential (GWP)	R134a 28 g 0.040 t 1430	R134a 38 g 0.054 t 1430
Energy Class (A – G)	B	–
Weight (kg, approx.)	8.5	10,5
Test marks	TÜV/GS, E-certified (Automotive EMC Directive)	



TECHNICAL DATA				
COMPRESSOR COOLERS	NEW CFF 20	CFF 35	CFF 45	NEW CFF 70DZ
Ref. No.	9600028325*	9600024842*	9600012982*	9600028329*
Ref. No. UK	9600028326	9600026458	9600026459	9600028330
Total Volume (l, approx.)	21	34	44	70 (30/40)
Connections	12 / 24 V DC / 100–240 V AC			
Temperature range (°C)	+20 to -18			
Power input (watts, approx.)	48	53	53	53
Refrigerant	R 134a	R 134a	R 134a	R 134a
Refrigerant quantity	28 g	40 g	50 g	34 g
CO ₂ equivalent	0.040 t	0.057 t	0.072 t	0.049 t
Global warming potential (GWP)	1430	1430	1430	1430
Energy Class (A – G)	C	D	C	D
Weight (kg, approx.)	10.5	17.2	18.6	26
Test marks	TÜV/GS, E-certified (Automotive EMC Directive)			

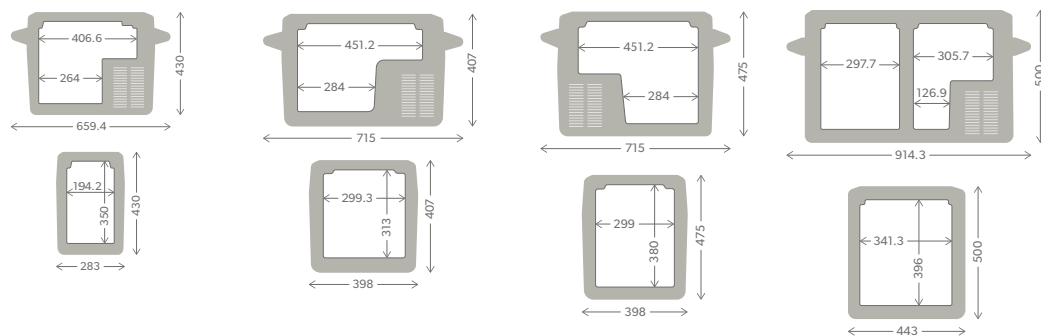

TECHNICAL DATA				
COMPRESSOR COOLERS	NEW CFX3 25	CFX3 35	CFX3 45	CFX3 55
Ref. No.	9600028369	9600025324	9600025326	9600025328
Ref. No. UK	9600028463	9600025325	9600025327	9600025329
Total Volume (l, approx.) incl. for fresh food (l)	25	36	46	55
Connections	12 / 24 V DC / 100 – 240 V AC			
Temperature range (°C)	+20 to –22			
Power input (watts, approx.)	46	50	52	50
Refrigerant Refrigerant quantity CO ₂ equivalent Global warming potential (GWP)	R 134a 32 g 0.046 t 1430	R 134a 38 g 0.054 t 1430	R 134a 42 g 0.060 t 1430	R 134a 45 g 0.064 t 1430
Energy Class (A – G)	C	C	C	C
Weight (kg, approx.)	12.7	16.9	18.7	20.4
Protection class	IP44, colour display IP64			
Test marks	TÜV/GS, E-certified (Automotive EMC Directive)			
Fridge slide	–	9600028548	9600028548	9600028549
Protective Cover	9600028749	9600028455	9600028456	9600028457

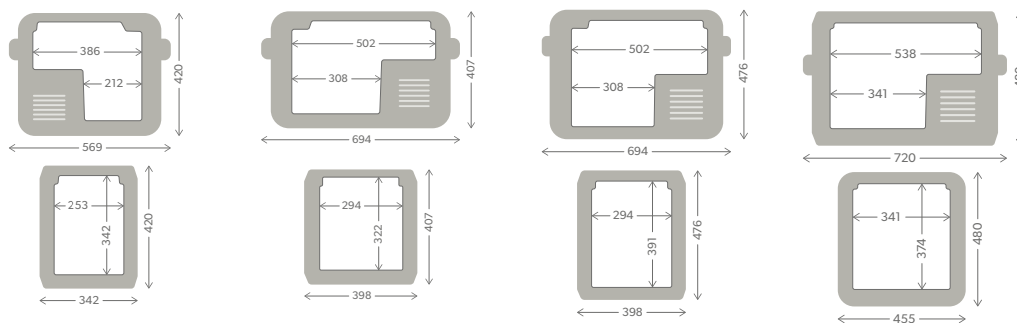



CFX3 55IM
incl. removable icetrays



CFX3 75DZ



CFX3 95DZ





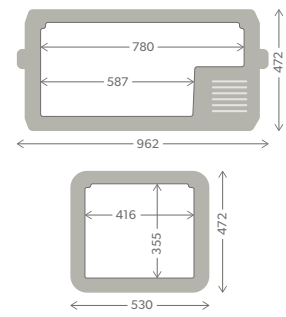
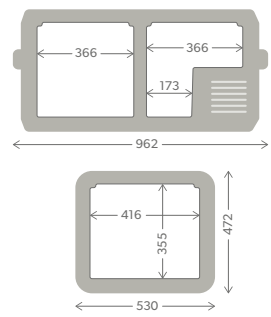
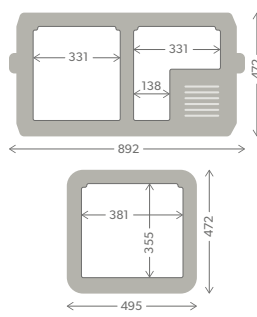
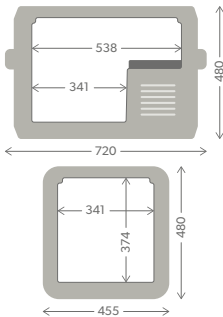

CFX3 100

9600025330	9600025332*	9600025334*	9600025336*
9600025331	9600025333	9600025335	9600025337
53	75 (45/30)	94 (55/39)	99
12 / 24 V DC / 100 – 240 V AC			
+20 to –22			
52	59	61	73
R 134a 45 g 0.064 t 1430	R 134a 59 g 0.084 t 1430	R 134a 67 g 0.096 t 1430	R 134a 60 g 0.086 t 1430
C	D	D	D
21.3	27.8	29.8	29.6
IP44, colour display IP64			
TÜV/GS, E-certified (Automotive EMC Directive)			
9600028549	9600028550	9600028551	9600028551
9600028457	9600028458	9600028459	9600028460





* Not available in Switzerland.

TECHNICAL DATA COMPRESSOR COOLERS / ABSORPTION COOLERS	 CK 40D HYBRID	 NEW ACX3 40G	 NEW ACX3 30	 NEW ACX3 40
Ref. No.	960000774 (EU) 9600026455 (UK)	9600028414 (EU) 9600028412 (UK)	9600028403 (D 50 mbar) 9600028404 (DK, FI, N, S) 9600028405 (UK) 9600028406 (F, I, E, NL) 9600028413 (D 30 mbar)**	9600028407 (D 50 mbar) 9600028408 (DK, FI, N, S) 9600028409 (UK) 9600028410 (F, I, E, NL) 9600028411 (D 30 mbar)** 9600028412 (UK) 9600028414 (EU)
Total Volume (l, approx.)	40	41	33	41
Connections	12 V DC (thermoelectrics) 230 V AC (compressor)	12 V DC / 230 V AC Gas cartridge	12 V DC / 230 V AC LPG	12 V DC / 230 V AC LPG
Consumption at 12 volts DC (watts) at 230 volts AC (watts) Gas (g/24h)	3.9 at +20 °C ambient temperature, at +5 °C interior temperature	85 85 30 mbar: 12.6	75 75 50 mbar: 12.6 30 mbar: 12,6	85 85 50 mbar: 12.6 30 mbar: 12,6
Temperature range Cooling below ambient temperature (°C, approx.)	DC: to 20* AC: +10 to -15	max. 30	max. 30	max. 30
Refrigerant Refrigerant quantity	R600a 15	-	-	-
Energy Class (A – G)	-	-	-	-
System	Thermoelectrics + 230-V compressor, electronic thermostat in compressor mode	Absorption cooling	Absorption cooling	Absorption cooling
Weight (kg, approx.)	22	16	14	15
Test marks	TÜV/GS, E-certified (Automotive EMC Directive)	Certified to European Gas Appliance Directive 90/396/EEC		

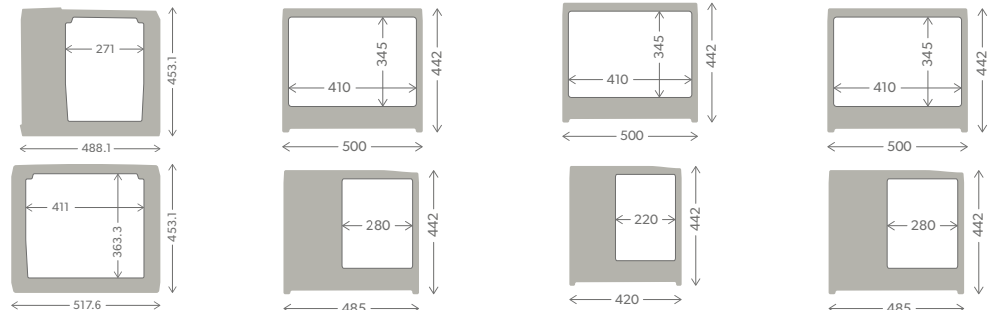
* below ambient temperature
** with hose, only permitted
for use on a gas socket (coupling)



TECHNICAL DATA ELECTRONIC ACCESSORIES FOR COOLERS	 PLB40 Lithium Iron Phosphate battery	 EPS817 Mains adapter for connecting thermoelectric 12-volt cooling appliances	 EPS100 Mains adapter for connection of 24-volt compressor cooling appliances to the 230-volt mains systems
Ref. No.	9600012878	9600000439	9600000440
Battery capacity (Ah)	40 / 512 Wh	-	-
Chemistry	LiFePO4	-	-
Input voltage	-	230 V AC / 50 Hz	230 V AC
Output voltage	-	13 V DC	25 V DC
Battery voltage	12.8 V DC	60 mA	12/24 V DC
Continuous load	-	6 A	-
DC output amps	15	-	-
Continuous output (W)	150 (per 12 V connection)	-	-
Dimensions (W x H x D,mm)	197 x 257 x 197	115 x 64 x 170	115 x 65 x 182
Weight (kg)	7.54	0.6	0.7



Dometic is a global company that makes mobile living easy – by providing great solutions to satisfy people’s essential needs when they are on the move. Like cooking, taking care of personal hygiene and maintaining a pleasant temperature. We offer smart and reliable products with outstanding design.





THE FULL RANGE

View Products:
dometic.com

UNITED KINGDOM
DOMETIC UK LTD.

Dometic House, The Brewery,
Blandford St. Mary
Dorset DT11 9LS
Tel 0344 626 0133
Fax 0344 626 0143
Mail sales@dometic.co.uk
Net dometic.com

GERMANY
DOMETIC GERMANY GMBH

Hollefeldstraße 63
D-48282 Emsdetten
Tel +49 (0) 2572 879-0
Fax +49 (0) 2572 879-300
Mail info@dometic-waeco.de
Net dometic.com

